

INTRODUCTION

The Diamond Audio D3 Series Amplifiers incorporate the following features:

- Full frequency response with low distortion and exceptional signal to noise performance.
- Advanced circuit design that features stereo, mono and mixed mode operation for use in a variety of systems.
- Variable high-pass/low-pass electronic crossover with a 12 dB per octave slope and fully adjustable range (55 Hz~550 Hz).
- Variable bass boost circuit to reinforce low frequency signals.
- Adjustable input level controls with ground loop isolation accepting a wide range of input signals.
- Remote turn-on with "soft start" muting to prevent turn on "thump" .
- Pulse-width modulated (PWM) MOSFET power supply with low AM RFI and protection circuits for overheating and speaker shorts.
- Nickel-plated input/output connectors and an external automotive type fuse.
- Aluminum heatsink for efficient heat dissipation.
- Low profile, compact size for space limited installs

TABLE OF CONTENTS

■ Description	1
■ Specifications	2
■ Power and Speaker Connections	2
■ Input Connections and Audio Control	3
■ Setting the Gain	4
■ Setting the Crossover	4
■ Setting the Bass Boost	4
■ Troubleshooting	4
■ System Diagrams	5

DESCRIPTION

The D3 Series Amplifiers provide a wide range of power and features that make them an excellent choice for a variety of car audio sound system configurations.

D3 Amplifiers use an unregulated power supply for good control of output power. This power supply design helps yield maximum power transfer with a minimum of heat loss. On board noise filtration is used to keep unwanted noise from leaking into the system from the amplifier. Each D3 amplifier comes complete with thermal, short, and load protection circuits as well.

All connections and controls for the D3 Amplifiers are located on the end panels. Plated connections ensure excellent conductivity and good looks. Easy to understand controls make setting the amplifier up correctly an easy task.

SPECIFICATIONS

	D3 400.2	D3 400.4
■ 4 Ohm Stereo Output	132w@1%THD	57w@1%THD
■ 2 Ohm Stereo Output	210w@1%THD	88w@1%THD
■ 4 Ohm Mono Output	420w@1%THD	182w@1%THD
■ Frequency Response	20Hz~20KHz	20Hz~20KHz
■ Signal-to-Noise Ratio	>100dB	>100dB
■ THD	.05%	.05%
■ Input Sensitivity	250mV~2.5V	250mV~2.5V
■ High Level Input Sensitivity	500mV~5V	500mV~5V
■ Power Supply Operating Range	10.8V~15.6V	10.8V~15.6V
■ Dimensions	2 1/4" H x 8 1/2" W x 12" L	2 1/4" H x 8 1/2" W x 13" L

POWER AND SPEAKER CONNECTIONS

The following figures show the power/output end panels for each amplifier along with a key to show the layout of each amp.

Fig.1 D3 400.2

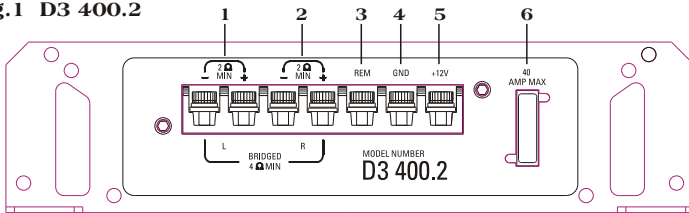

- | | |
|-------------------------------|----------------------|
| 1. Left Speaker Output | 4. Ground Input |
| 2. Right Front Speaker Output | 5. Battery+12V Input |
| 3. Remote turn-on Input | 6. 40 Amp Fuse |

Fig.2 D3 400.4

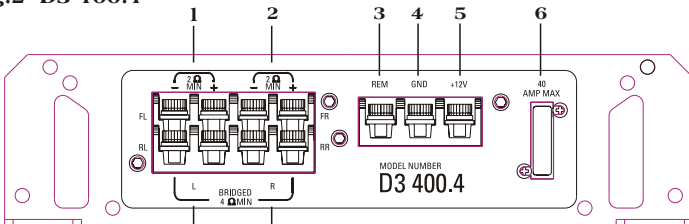

- | | |
|-------------------------------|------------------------------|
| 1. Left Front Speaker Output | 5. Battery+12v Input |
| 2. Right Front Speaker Output | 6. 40 Amp Fuse |
| 3. Remote Turn-on Input | 7. Left Rear Speaker Output |
| 4. Ground Input | 8. Right Rear Speaker Output |

INPUT CONNECTIONS AND AUDIO CONTROL

The following figures show the input/audio control end panels for each amplifier along with a key to show the layout.

Fig.3 D3 400.2

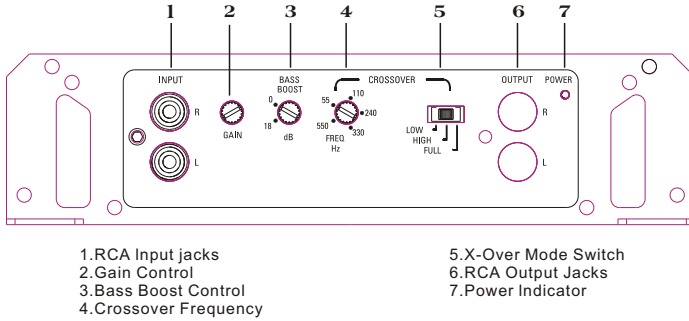
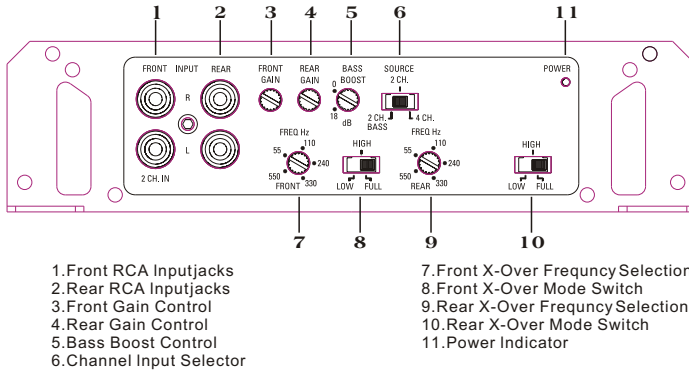

Fig.4 D3 400.4



- **Gain Control** : Allows the nominal operating level of the amplifier to be set in conjunction with the level of input voltage from the source unit. The D3 amplifiers will accommodate low level (RCA) input ranging from 500 mV~5 V.
- **Bass Boost** : Acts like an equalizer with an adjustable gain fixed at 45 Hz. This adjustment gives you up to 18 dB of boost at that frequency. This can be used to compensate for lack of low-frequency response in the car audio environment.
- **Crossover Frequency Selection** : The crossover frequency is fully adjustable between 55 Hz and 550 Hz.
- **Crossover Mode Switch** : Switches crossover between off, low-pass, or high-pass. When in the LP or HP position, a 12 dB per octave slope is implemented at the frequency selected on the Frequency Knob.
- **Input Mode Switch** : Sets the input mode of the amplifier, depending on its purpose in the system. Can be set to Stereo Mode, Bridged Mode, or Mono Mode.
- **Rear Channel Input Select (4 channel only)** : Allows channels 3 & 4 to use either set of inputs (front or rear) for signal.

SETTING THE GAIN

The best way to set the gains on any amplifier is with an oscilloscope and test tone. Using the scope will ensure the amplifier is not clipping and protect your system from being damaged from being overdriven. If you have an oscilloscope and need help using it, feel free to call DAT Technical Support for help.

Another way is with a multi-meter and test tone. Set the multi-meter to DC voltage, play the test tone at 75% volume. Tune gains up until DC voltage is present, then back the gains back down a little.

If an oscilloscope, multi-meter, or test tone is not available, find out the output signal voltage of the head unit. Match the gain knob with that amount of voltage. It should be between 500 mV and 5 V. If it is above 5 V, the head unit has too much signal and the amp will clip even with the gain set at minimum. Turn system on and volume to 75%, if there is noticeable distortion, gains should be tuned down some.

SETTING THE CROSSOVER

Select LP or HP using the Crossover Mode Switch, select desired frequency by turning the Frequency Knob.

SETTING THE BASS BOOST

If there is a noticeable lack of low end frequency, the bass boost can be used to raise the level of bass in the system. Turn the system on to normal listening levels and raise the bass boost until the level of bass is satisfactory.

Caution: If "popping", "crackling", or any other unusual noise is heard from the system when using the bass boost, immediately turn the boost down to avoid damaging components in the system. Also, if the bass sounds "muddy" or distorted, turn the bass boost down.

TROUBLESHOOTING

Problem :

No Audio Output

Solution :

Low or no turn-on voltage. Check remote connections at amp and head unit.

Check remote voltage at amp with multi-meter, there should be around 12 volts when head unit is on.

Blown Fuse. Check both main system fuse and amplifier fuse. If blown, replace with fuse of same type and rating.

Loose Connections. Check all power and signal wires to make sure they have solid connection.

Speaker lead shorted. Check all speaker wire to make sure they are not shorted out somewhere.

Blown speakers. Check speaker impedance with multi-meter, if the woofer is blown, it will read a dead short.

Problem :

Amplifier cycles on and off.

Solution :

Thermal protection circuits are shutting the amplifier off. Check location of amplifier for adequate ventilation. Check impedance at amplifier for correct load. Check voltage at amplifier for low voltage.

Problem :

Distorted audio.

Solution :

Check that gains are set correctly. Inspect speakers for damaged cones or bad voice coils.

Problem :

Amplifier fuse keeps blowing.

Solution:

Check all power and signal wires for a short. Make sure power and ground wires are correctly connected to the amp.

Problem :

Whining, ticking, or any other unwanted noise present in system when engine is running.

Solution :

Amplifier may be picking up alternator or radiated noise. Make sure all signal wires are separated from power wires. Check all signal and power wires for a solid connection. Check all ground wires to make sure they have a solid ground. Check alternator and/or voltage regulator for solid connections. Check battery for adequate voltage and connection.

If you have any questions or need added help with your new D3 Amplifier, please feel free to call Diamond Technical Support at 1-866-328-2834.

SYSTEM DIAGRAMS

The Diamond Audio D3 400.2 (Fig. 5 to 7) and D3 400.4 (fig. 8 to 13) 2 and 4-channel car audio amplifiers can be used in a variety of system applications. Here are some examples to plan your own installation

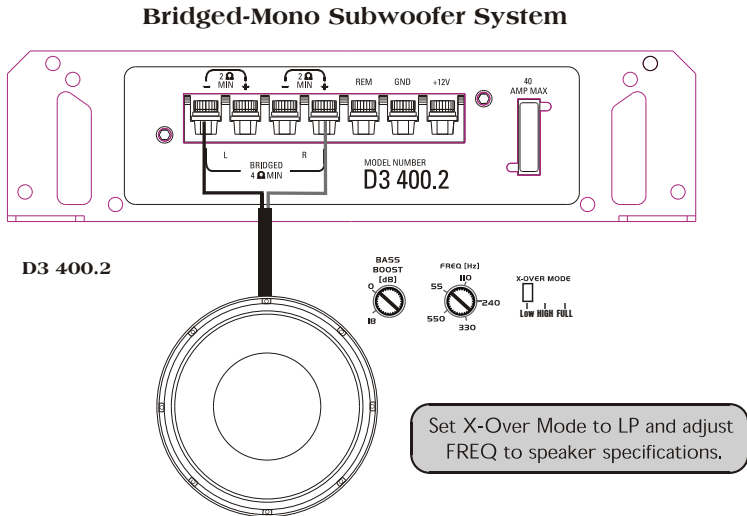

Fig.5 In this application the amplifier is bridged for mono operation to drive a subwoofer

2-Channel Full-Range, Satellite, of Subwoofer Stereo System

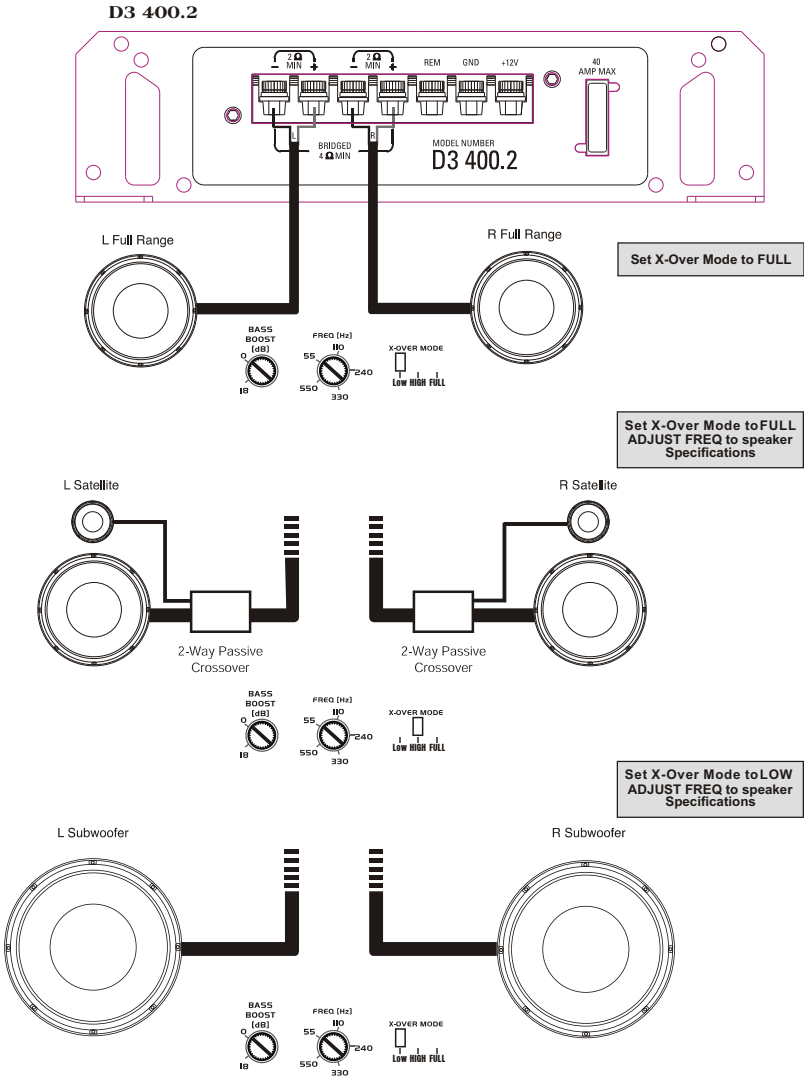
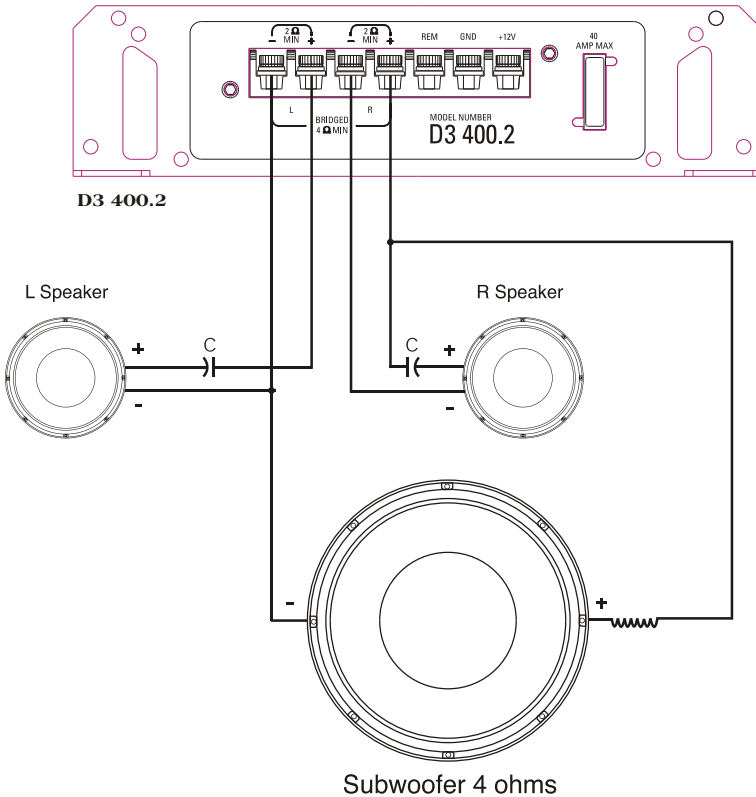

Fig.6 In this application, the amplifier is used in stereo and drives two full-range (or satellite or subwoofer) speakers. NOTE : A passive crossover must be used with satellite speakers.

Mixed-Mode Satellite and Subwoofer System



FREQ (hz)	L (mH)	C (uF)
80	8.0	497
100	6.4	398
125	5.1	318
150	4.2	265
200	3.2	199



Set X-Over Mode to FULL.

NOTE : Chart values based on 4 ohm speakers.

Fig.7 The amplifier can be configured for a mixed-mode operation. The table provides component values to create a 6dB per octave crossover at specified frequencies. Use components that have a $\pm 5\%$ tolerance and capacitors rated at 100V. NOTE : Choose the same frequency for both LP and HP crossovers. Do not overlap frequencies, as this may damage the amplifier.

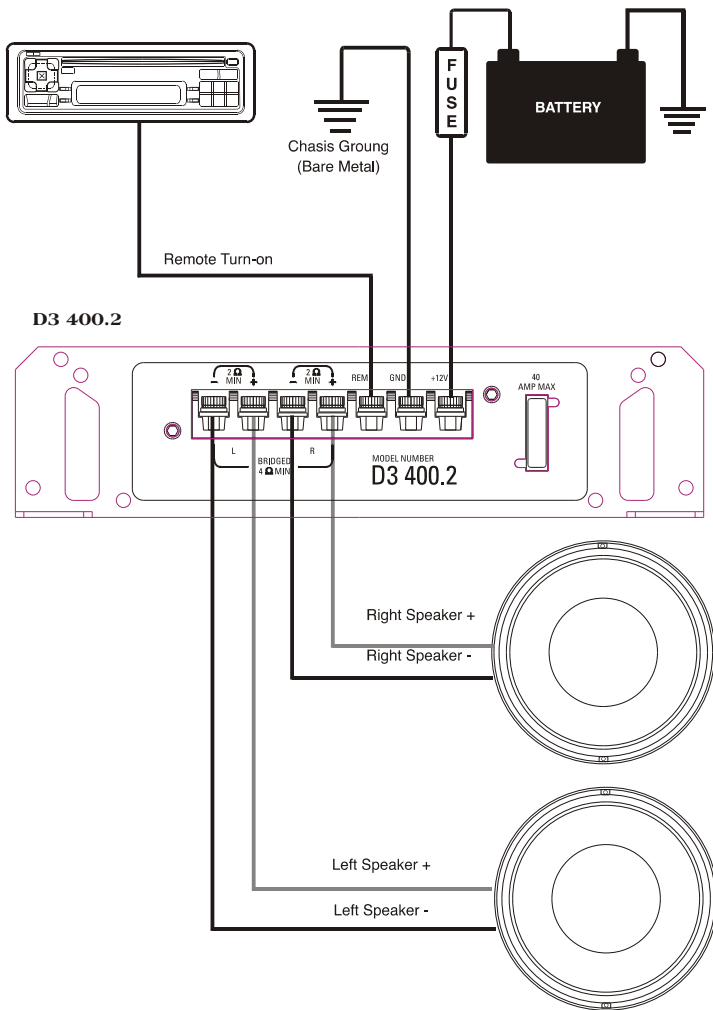

Fig.8 Electrical connections for the D3 400.2

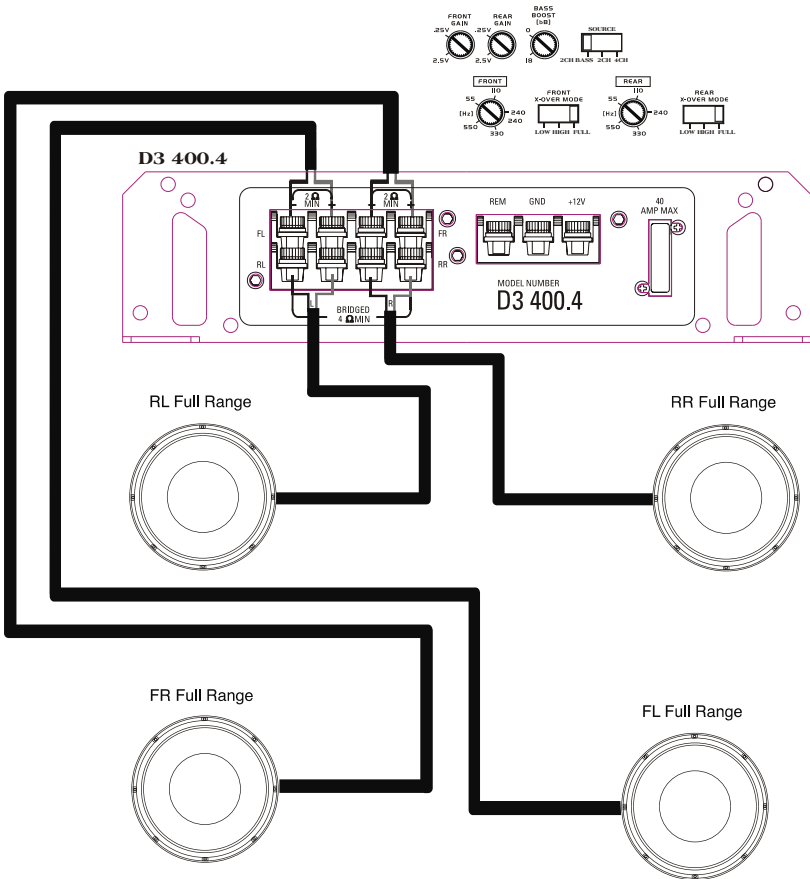

Fig.9 In this application, the D3 400.4 was used as a 4-channel amplifier to drive four full-range speakers in stereo.

4-Channel Stereo System 2-Channel High-Pass. 2-Channel Low-Pass

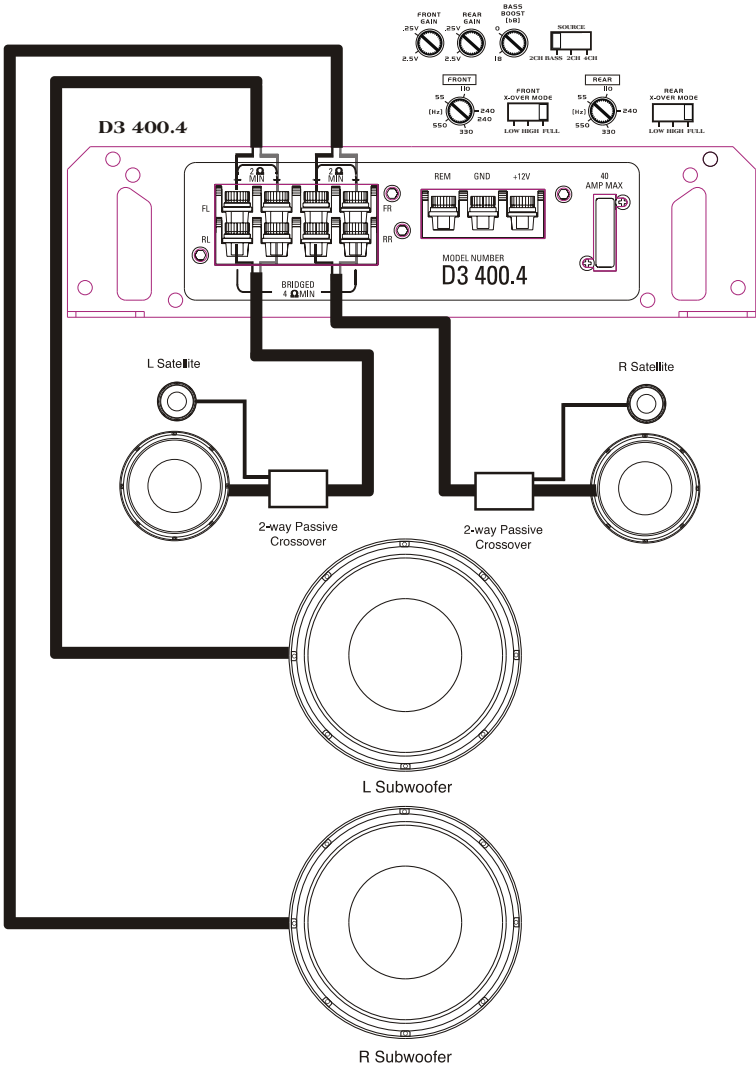

Fig.10 In this 4-channel system, the D3 400.4 drives a pair of satellites and a pair of subwoofers. Note the filter settings.

2-Channel Stereo System with Low-pass Bridged Mono Channel

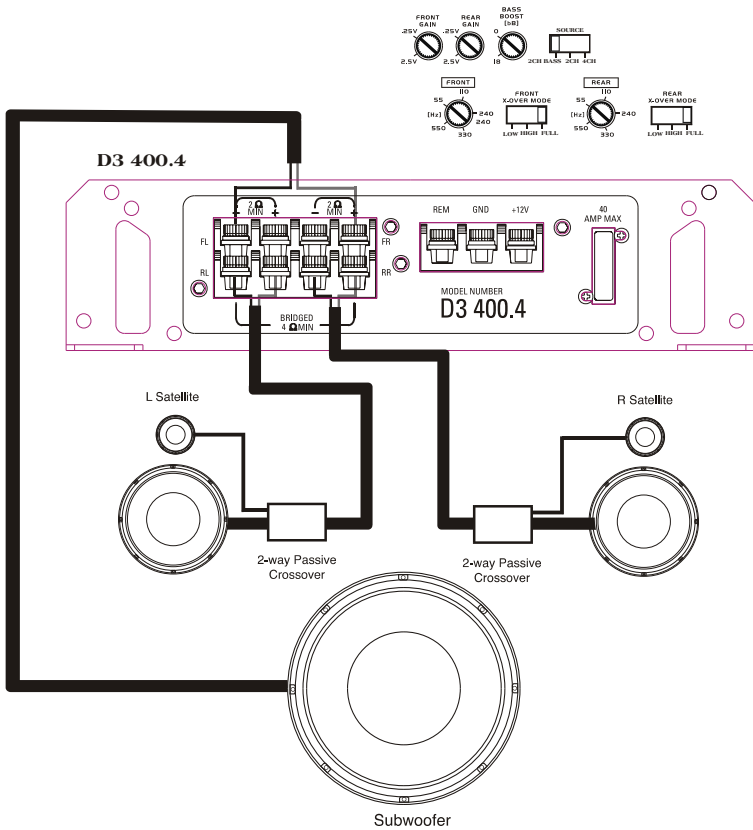

Fig. 11 The D3 400.4 can also be used to drive a pair of stereo satellites and a single mono subwoofer. Note the filter settings

2-Channel High Power Systems (Satellite or Subwoofer)

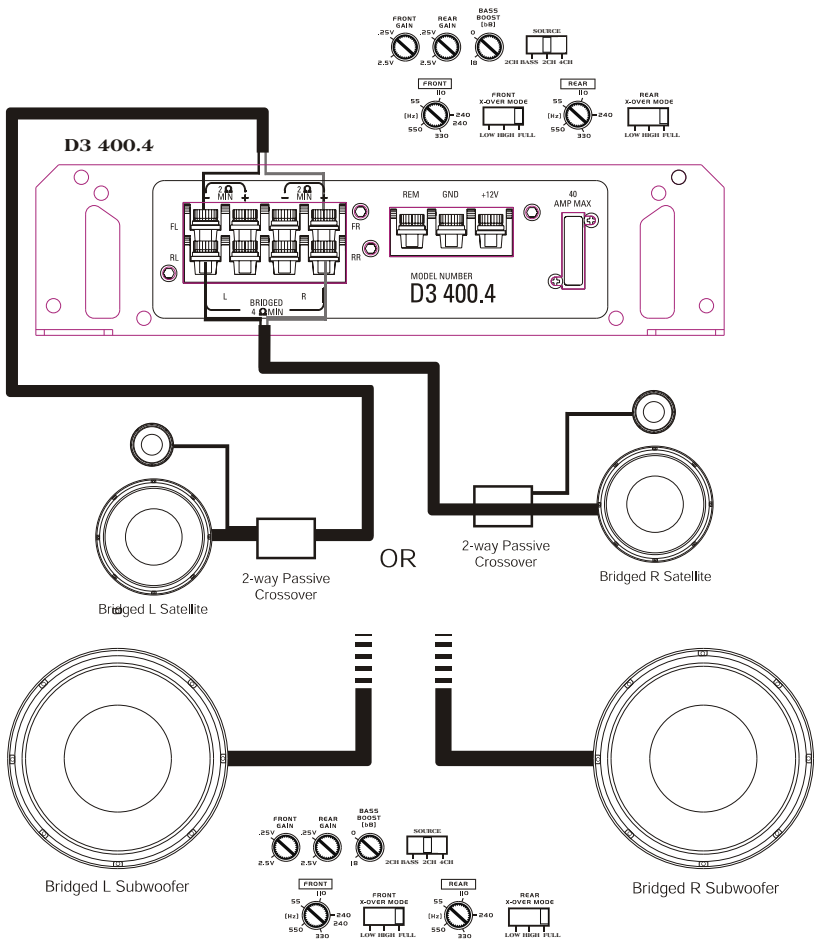
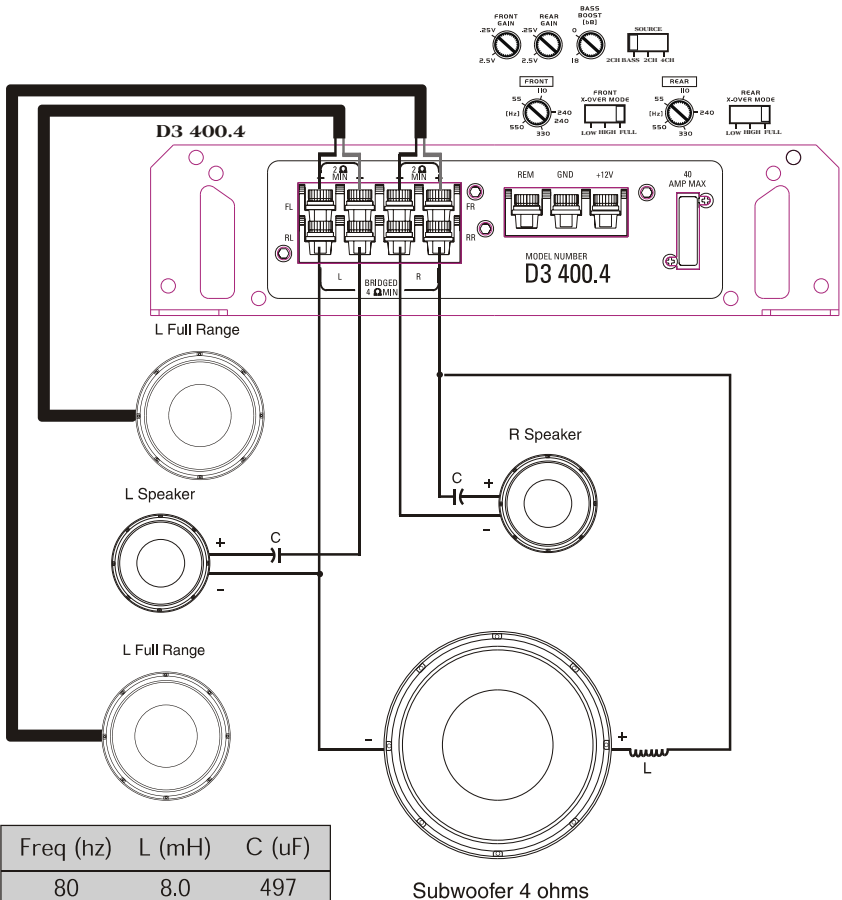

Fig.12 The D3 400.4 can also be set up as a 2-channel high-power amplifier to drive a pair of satellites (or subwoofers).

Mixed-Mode System On Rear ; Full-Range Speakers On Front



Freq (hz)	L (mH)	C (uF)
80	8.0	497
100	6.4	398
125	5.1	318
150	4.2	265
200	3.2	199

NOTE : Chart values based on 4 ohm speakers.

Fig. 13 The amplifier can be configured for a mixed-mode operation on either channels 1/2 or 3/4 amplifier sections. The table provides component values to create a 6dB per octave crossover at specified frequencies. Use the same frequency for both LP and HP crossovers. Do not overlap frequencies, as this may damage the amplifier.

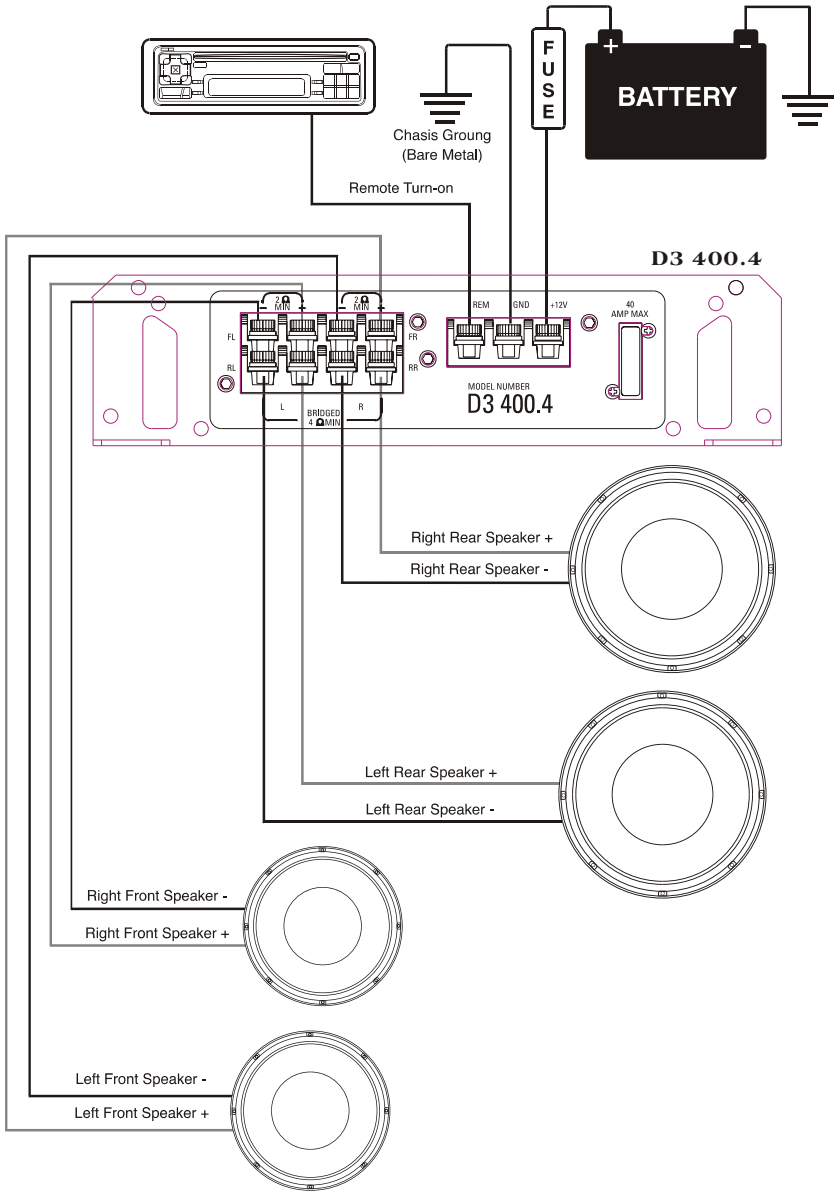

Fig.14 Electrical connections for the D3 400.4



**DIAMOND
AUDIO TECHNOLOGY**

**Listen as the
Artist Intended**

Head Office
410 5. Benson Lane
Chandler, AZ 85224

Tel : 480-813-6200
Fax : 480-813-6210

Service/Tech Support
Toll Free 1-886-328-2834
tech@diamondaudio.com

www.diamondaudio.com

LIMITED WARRANTY STATEMENT

Diamond Audio Technology, Inc. (DAT) warrants all DAT products to be free of defects in material and workmanship for a period of one (1) year from the date of original purchase provided they are purchased from an authorized DAT retailer in the United States. However, the effective warranty period will be three (3) years if the products were purchased from and installed by an authorized DAT retailer.

What is covered: Parts and labor to effect repair or, at the sole discretion of DAT, replacement of either any malfunctioning or defective part(s) or the entire system should the system or any component part(s) thereof fail to perform as designed. Includes return freight via ground transportation to destinations within the United States.

What is NOT covered: Installation or setup and repair or replacement of the system or any parts thereof which, in DAT's judgment, fail or become damaged as a result of negligence, improper use, abuse, unauthorized modification or service, improper or inadequate packaging during shipment, installation by a non-authorized dealer, accident, or use for any purpose other than those for which this product was originally intended, or where the model's serial number has been removed, altered or defaced.

Who is covered: Original purchaser so long as they reside in the United States and can provide proof of the original date of purchase (e.g., store receipt) from an authorized DAT retailer.

OUTSIDE THE UNITED STATES:

Customers outside the United States should contact their local sales office to obtain information on prices, exchange unit availability, instructions, service and warranty/non-warranty repairs.

Repair or replacement under this warranty is the exclusive remedy of the consumer. DAT shall not be liable for any incidental or consequential damages for breach of any expressed or implied warranty on this product. Except to the extent prohibited by applicable law, any implied warranty of merchantability or fitness for a particular purpose on this product is limited in duration to the duration of this warranty. Some states do not allow the exclusion or limitation of incidental or consequential damages, or allow limitations on how long an implied warranty lasts, so the above limitations or exclusions may not apply to you. This warranty gives you specific legal rights and you may also have other rights that may vary from state to state.

HOW TO OBTAIN WARRANTY SERVICE

In the event a DAT product should require servicing, you should (a) visit an authorized DAT retailer or (b) call the DAT Service Dept. at (866) 328 2834. To be eligible for warranty service within a three (3) year period, the accompanying receipt of original purchase from an authorized DAT retailer must specifically note that dealer installation was provided.

Product returned for repair/service must be properly packaged and clearly marked with the Return Authorization (RA) number issued by DAT. If the RA number is not clearly marked on the package or no RA number was issued by DAT, the product may be refused upon delivery. DAT does not assume responsibility for lost or misdirected product.



DIAMOND
AUDIO TECHNOLOGY



PROFESSIONAL REFERENCE AMPLIFIER

400.2 & 400.4
Owner's Guide

Serial Number _____ Date of Purchase _____

www.diamondaudio.com